

SUKHOI

SU-27

*for 2 AMT Mercury
or 2 Jet CAT P 80 / 120*

Assembly Manual

AVIATION DESIGN

ZI le chenet, 91490 Milly La Foret, FRANCE

Tel : 33 1 64 98 93 93

Fax : 33 1 64 98 93 88

E-mail : aviation.design@wanadoo.fr

www.adjets.com

Version 01:09:2009

INTRODUCTION

The Su-27 from **AVIATION DESIGN** is designed for high thrust jet engines.

It is a scale kit, with all the panel lines engraved in the fuselage and a lot of scale details (gears, hinges, cockpit...). It is fully molded in fiberglass, carbon and epoxy. Up to 80% of the work is done in our factory.

The flight characteristics are excellent with low and high speed capability.

The model has plug in wings, stabs and fins.

The Sukhoi will operate from prepared grass fields (70 meters long) or tarmac surfaces.

KIT FEATURES

- High quality, grey gel-coated epoxy-glass fuselage. All the panel lines are engraved. The fuselage is in 2 parts for shipping.
- Nose cone and central tail boom in epoxy glass
- Air brake molded in epoxy-glass
- Main gear doors
- Canopy frame molded in epoxy-glass
- 2 Exhaust nozzle.
- 2 Epoxy-glass inlets
- 2 Epoxy-glass ductings
- Fully molded epoxy carbon wings and stabs with aluminium spar already glued.
- Fully molded epoxy carbon fins with aluminium spar already glued
- 2 ventral fin in epoxy
- Wing tip rails
- All plywood and wood parts pre-cut to shape where necessary.
- Air cylinder for air brake.
- All hardware necessary.



Following items are included in the kit

For the fuselage :

a set of screws + blind nuts for the gear

For the canopy, 1 hatch latch

For the air brake, 1 air cylinder + tubing and air valve

For the stabs :

4 ball bearing for the stabs

4 ball bearing mounting

8 screws M3x16 mm long

2 aluminium link M4

2 threaded rod M4

2 carbon control horns

- ABS cockpit interior and scale accessories.
- Clear formed canopy.
- Cockpit detail kit include 1/8 full body jet pilot, 1/8 ejector seat & instrument panel.
- pitot probes and incidence probes.
- vacuum parts
- instructions in English and plan.

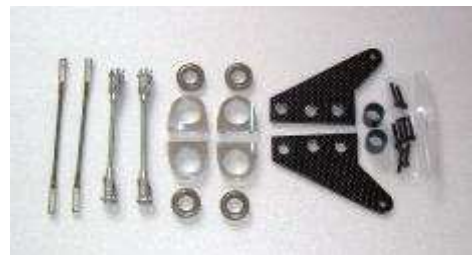

To complete the kit :

The following items are not included in the kit. They are available from **AVIATION DESIGN**.

Cockpit detail kit :

This kit include :

1/8full body jet pilot, 1/8 ejector seat & instrument panel.



Probes set :

- pitot probes and incidence probes for the Su 35.



Landing gear :

AVIATION DESIGN scale retractable landing gear is specially designed for the Sukhoi.

It is made all CNC in aluminium

For the gear, it includes 3 rotating retracts system, 3 oleo legs, 4 way valve, tubing, connectors, air tank, filling valve.

It also includes 2 x 125 mm diameter wheels + scale cover + brakes and 2 x 75 mm diameter front wheels

It includes valve, tubing, connectors, air tank, filling valve.



Gear doors kit :

Include 3 air cylinders, electronic gear door cycler, 4 way valve, tubing, connectors, air tank, door hinges, ball links



Air brake :

Include special air cylinders, 4 way valve, tubing, connectors,



2 Kevlar Fuel tanks : ref ADJ 450

2 Fuels cells molded in kevlar. Capacity : 2 x 2.4 liters
It includes also all tubing and upper tank



2 stainless steel tailpipe : ref : ADJ 460



Super scale water decals :



Jet Engines :

2 Complete AMT Mercury
or 2 Jet Cat P120

DISCLAIMER

AVIATION DESIGN assumes no liability for the operation and use of these products.

The owner and operator of these products should have the necessary experience and exercise common sense. Said owner and operator must have a valid Model Airplane license and insurance, as required.

FIBREGLASS PREPARATION

The inside of the fuselage should be sanded with fresh #80 grit paper for best glue adhesion where bulkheads and other attachments are fixed.

GLUING TECHNIQUES

All the plywood formers should be fitted with cyano adhesive and then glued with epoxy and glass fiber tape. All other parts should be glued with epoxy.

To complete the kit :

The following items are not included in the kit. They are available from **AVIATION DESIGN**.

CONSTRUCTION

Front FUSELAGE

Gear doors :

Cut just one side off the front gear door according to the engraved panel lines.

Glue the 3 door hinges with cyano (take care of the position according to the plan).



Finish to cut the front gear door 15 mm longer than the engraved panel lines (10 mm forward, 5 mm backward).

Make 2 fence in the front gear door according to the engraved panel line

Glues with CA the plastic vacuum parts in the front gear door



Frame :

Assemble the frame C1, C2 and C3

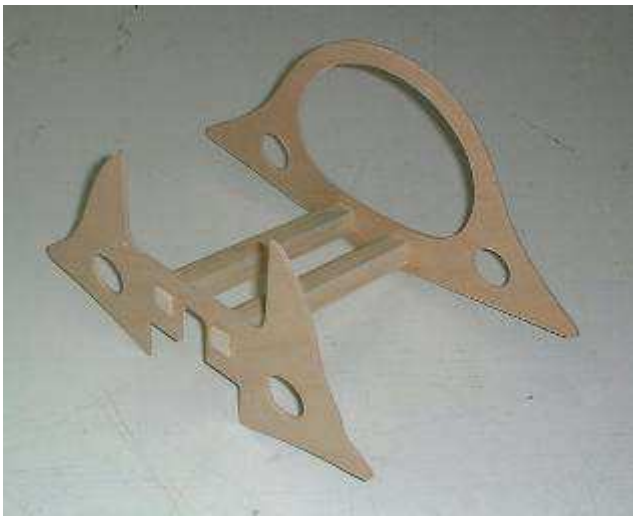

Desassemble them , fit them in the fuselage and assemble them.

Glue them in the fuselage according to the plan (check distance between the C2 former and the fuselage end)

Epoxy the bulkheads in place : the 2 formers must be glued with epoxy and glass fiber.

Cut some glassfibre tapes (30 mm large and 10 cm long).

Glue this tape with epoxy overlapping all the formers and the fuselage.

Let them dry overnight.

Rear FUSELAGE

Cut the 2 gear doors according to the engraved panel lines.

Also cut some 4 mm larg slot for the wood location, according to the photos and line drawn on the fuselage



Gear frame :

Insert 4 M3 blind nuts in C10

Screw the gear on C10 with 2x M3 x 12 alen screw



These 2 plywoods will be glued under the skin



Epoxy all the bulkheads in place : C10, C11, C12, C13, C14 must be glued with epoxy and glass fiber.
Cut some glassfibre tapes (30 mm large and 5 cm long).
Glue this tape with epoxy overlapping all the formers and the fuselage.

Screw the gear box to C14 with M3x12 allen screw putting some epoxy to C14.

Insert some tape **IN** the fuselage overlapping **all** the formers and the fuselage.
Check to glue **very strongly** C14 in the fuselage against the main fraime

Let them dry overnight.

Rear frame and bearing installation :

Cut out all hatches and make the necessary holes in the fuselage according to the photos.
Cut the back of the fuselage at the bearing position.

Cut the slot (6 mm larg, 20 mm height) in the fuselage (fin root location) for the elevator control horn
It will be covered by the fin

Glue the bearing in the mounting with threadlock glue.

Screw the 4 bearing mounting to the rear fuselage with M3x16 alen screw.



Screw the 2 servos (9 kg.cm torque) on each plywood frame C20.

Connect the 2 servos together and try them with your radio.
They must move without any bad noise

Insert them in the fuselage.

Check that they can move without problem.

Glue C20 with CA for the moment.

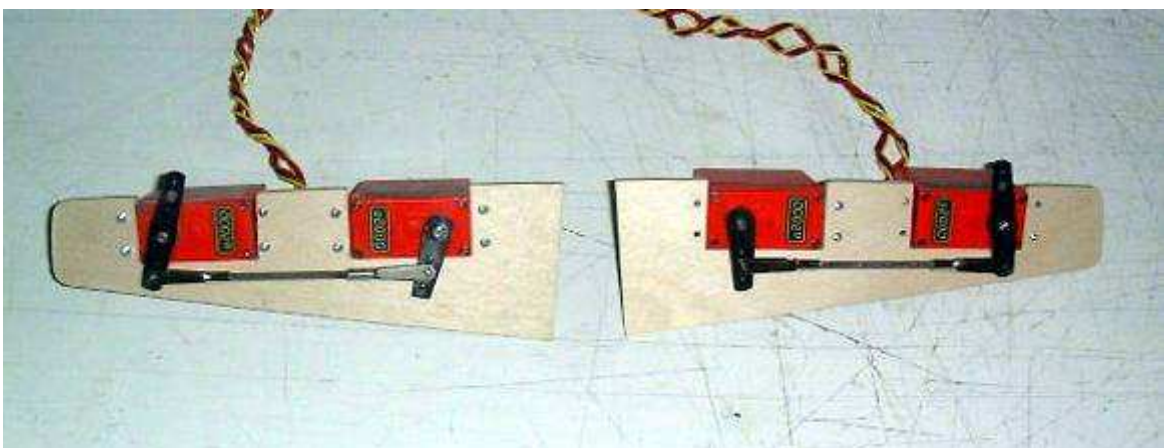

Fin assembly :

Trim all the parts of the fin.

Trim also the aluminium tube and pins

If necessary, drill again all the holes in the fuselage for the fin tube and pin

Insert some greass in the fuselage aluminium tube

Cut a fence in the back of the fit for the servo and ball link

Fit the fin on the fuselage.

Check that the servo can move without problem.

Drill a hole through the aluminium joining tube to secure the fin

Insert a screw to secure the fin



Stabs assembly :

First you have to balance the stabs.
Drill a hole in the stab root (leading edge)
Insert some lest (about 75 grammes) in each stabs

Fit the stab on the bearing fuselage to see if it is balanced well.
Glue the lest with epoxy

Insert the 12 mm washer on the aluminium tube
Fit the stab in the fuselage bearing

Secure the stab with a screw through the aluminium tube

Draw a line on the stab just in front of the servo arm
Cut a 2 mm larg slot for the carbon control horn

Fit the control horn in the stab and fit the fin on the fuselage.
Check that the control horn is just in the middle of the fin slot

Sand the carbon control horn for a best glue adhesion

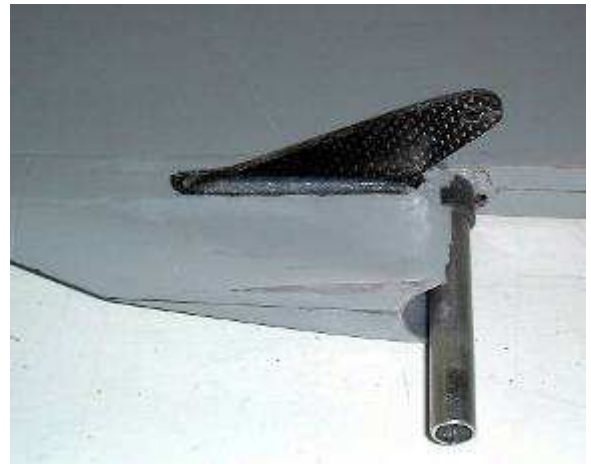

You can also drill some small holes in the bottom of the horn for best glue adhesion
Glue the control horn in the stab with epoxy
Let them dry overnight.

Connect the servo to the carbon control hon with the 2 M4 aluminium ball link and the M4 threaded rod



Air brake :

Fit the air brake on the fuselage.
Draw a line on the fuselage at 18 mm from the fuselage edge

Cut 2 slots in the air brake location fuselage
Check that the air brake can move without problem in this slot

Fit the air brake on the fuselage.
Drill a 2 mm diameter hole through the fuselage and the air brake just on the line
Take care that the 2 side holes are parallel

Fit a 2 mm piano wire through the fuselage and the air brake
And check that it can move without problem

For the air cylinder location, Cut a slot in the top of the fuselage according to the plan

Fit a 2 mm piano wire in the cylinder hole and glue the piano wire **IN** the fuselage according to the plan



Cut a slot in the air brake according to the plan



Glue the plywood control horn C24 in the air brake with epoxy

Fit the air brake on the fuselage with the piano wire
Connect the air cylinder to the control horn with the aluminium link

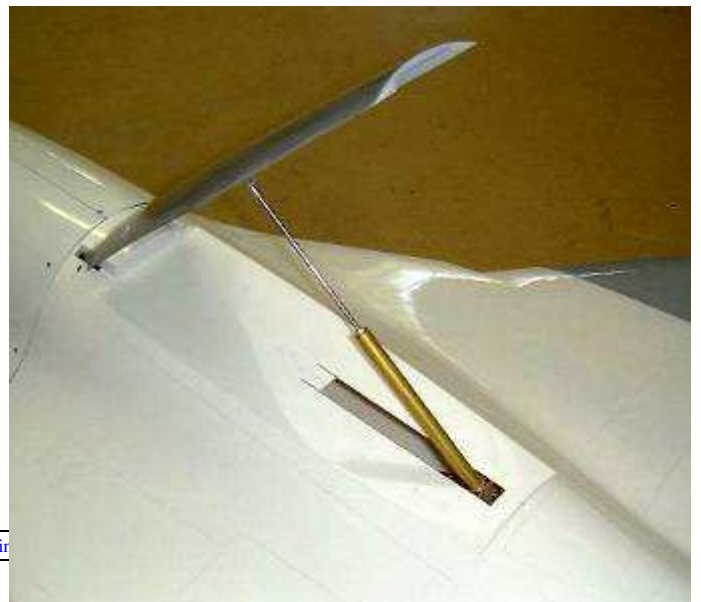

Air intakes

Glue with epoxy the plywood reinforcement C26

Cut the air intakes as engraved

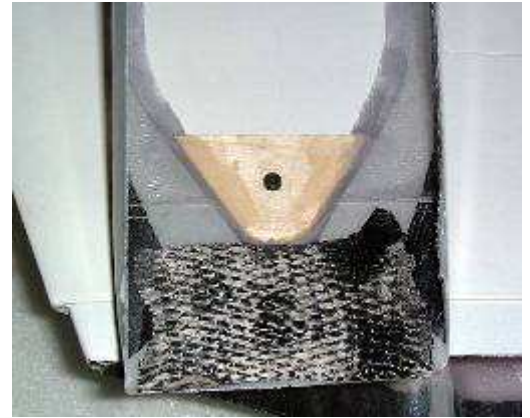

Fit the air intake on the fuselage.

Drill a 3 mm hole through the plywood reinforcement and the fuselage

Insert a 3 mm screw

Insert M3 blind nut in C25

Glue with epoxy C25 in the fuselage

Screw the air intake on the fuselage with a M3 screw



Drill 4 x 2 mm holes through the intake and C10

Screw the 4 parker screws

Unscrew the air intake from the fuselage. You will have now to glue the ducting in the air intake

Cut the back of the ducting so that it will not touch the engine mounting frame.

Fit the ducting in the air inlet and glue the leading edge with epoxy and microballon

Glue also the rear of the ducting to the air intake

Put some clothes pegs all around the intake leading edge during drying.

Let them dry overnight.

Trim all the leading edge.



Gear doors

Cut the main gear doors in 3 parts



Cut 2 slots in the fuselage as engraved for the 2 Robart door hinges.

Glue the 2 Robart hinges against the fuselage with CA, just in front of the 2 slots.
They must be outside of the fuselage.

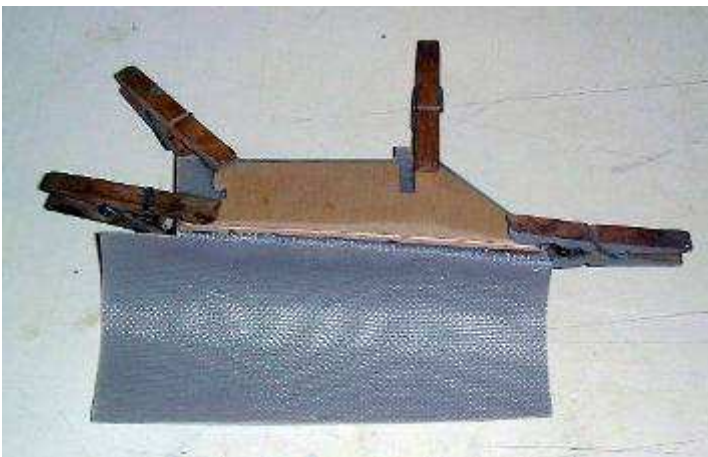

Glue the plywood reinforcement C28 on the main gear door with quick epoxy
Put 4 cloth pegs

Glue the 2 hinges on the gear door with epoxy. Adjust carefully them so that the gear door is in front of the fuselage hole
Secure the hinges with 2 parker screw and plywood reinforcement C29 inside



Drill a 2 mm hole at the end of the rear hinge
Insert the steel ball link for the air cylinder

Screw the ball link plastic end to the 2 '' air cylinder
Screw the air cylinder on the obechi block C30 with the parker screw

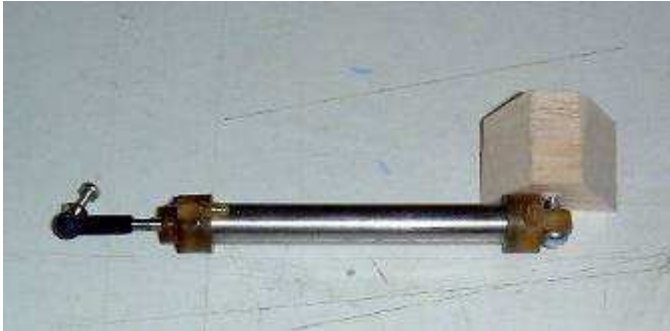

Extend the air cylinder
Fit the plastic ball link on the metal ball.

Glue with CA the obechi wood block on the fuselage to have to correct gear door angle (when the door is open)
Check that it close without problem



Rear gear door :

Glue the 2 door hinges with cyano (take care of the position according to the plan).
Cut the rear gear door according to the engraved panel line.



Glue with CA the fix piece on the fuselage



Check that it can open and close without problem

Fit a spring on the rear door hinges so that the door automatically close when the gear goes up.



Wings:

Cut the location of the 2 gear doors hinges in the wing according to the engraved panel line.



Wing tip missile rails :

Fit the wing tip missile rails with 2 parker screws 3x20



Drill a hole (about 15 mm diameter) in the top of the main frame for the electric wire and air tubing

Landing Gear :

Main gear :

You have now to connect all the gear, door and brake tubing.

Front gear

Screw the front landing gear on C2
Fit the steering control arm + the oleo legs on the retracts
Glue the ABS cover on the wheel hole

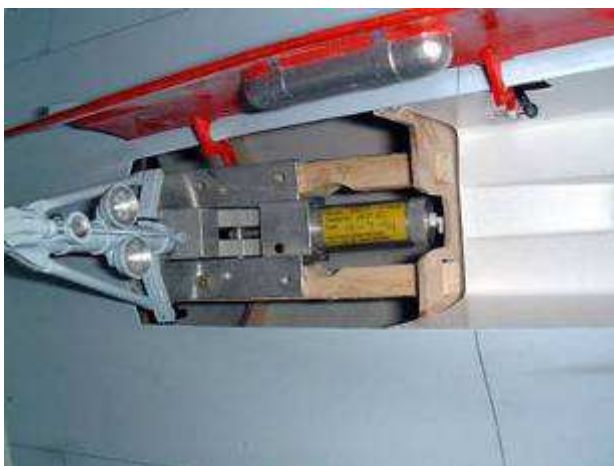

Screw the M2 ball link on the central door hinge
 Screw the air cylinder on the ply reinforcement C29.
 Connect the 1" air cylinder link to the ball link and check that the door closes perfectly : the door is open when the cylinder is fully extended and the door is closed when the air cylinder is retracted.
 Glue C29 on the fuselage.



Connect all tubing to the retract and the door cylinder.

Screw the steering servo on the C4 frame
 The steering servo should be a 4 kg.cm servo

Glue C4 on C2 just in front of the steering control arm
 Connect the servo to nose gear steering arm with 2 x M3 link and M3 threaded rod.



Nose

C33 will be removable for an easier access in the fuselage.
 Glue the 4 plywood reinforcement C32 in the fuselage according to the plan.
 C33 must slide between the 4 plywood parts C32
 Epoxy C32 in place : they must be glued with epoxy and glass fiber, overlapping all the formers and the fuselage.
 Insert C33 between C32. Drill a hole through C32 and C33 and fit a M3 screw + blind nut



Fuel tanks

You will now have to install the 2 fuel tanks in the fuselage before to continue the assembly.

Fit the 2 kevlar tanks in the fuselage against the main frame. Secure them with silicon glue

Glue with silicon glue the 2 upper tanks just in front of the main tanks

Assemble the fuselage

You have now to assemble the 2 part of the fuselage together.

If you have a Su 27, you can only screw the 2 parts together. It will be easier later to repair any damage.

Fit the 2 parts in front of each other.

Drill a 15 x 1.5 mm hole through the 2 parts to insert parker screw.

If you want only to screw the fuselage together (disassemble later), glue 15 x 3 mm plywood reinforcement on the hole location. Screw the 2 parts with 15 parker screws.

If you glue the 2 parts, put some epoxy on both side.

Fit the 2 parts together and screw au the parker screw. Let it dry overnight. Remove the screw after drying.



Assemble the central tail boom

If you want, you can only screw the 2 parts together. It will be easier for handling.

But it is also possible to glue it.

Fit the 2 parts in front of each other.

Drill a 6 x 1.5 mm hole through the 2 parts to insert parker screw.

Glue 6 x 3 mm plywood reinforcement on the hole location.

Screw the 2 parts with 6 parker screws

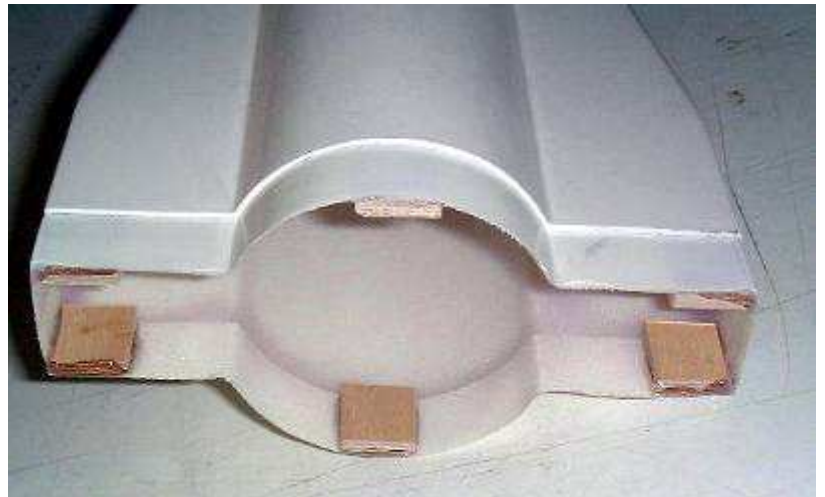

CANOPY :

Front canopy :

Cut the front fiberglass canopy
Cut the clear canopy in 2 parts
Cut the front clear canopy according to the engraved line
Glue the clear canopy INSIDE the fuselage with Zap canopy glue
Let it dry overnight.
Cut the front vacuum part. Paint it in black
Glue it inside the front canopy with Zap canopy glue
Let it dry overnight.



Glue the on the canopy with canopy with Zap canopy glue



Rear canopy :

Cut the rear fiberglass canopy from the canopy frame
Cut the rear clear canopy according to the engraved line
Glue the clear canopy INSIDE the canopy frame with Zap canopy glue
Let it dry overnight.
Cut the rear vacuum part. Paint it in grey
Glue it inside the canopy frame with Zap canopy glue
Let it dry overnight.



Insert the hatch latch in the fuselage to secure the canopy frame on the fuselage.

Cockpit

Paint all the part of the cockpit, instrument panel and ejector seat.

Ejector seat :

Cut the vaccum part according to the photo

Glue the 2 vaccum parts together with CA

Glue the plastic parts on the vaccum parts according to the photos.



Instrument panel :

Cut the vaccum part according to the photo

Glue the platic parts on the vaccum parts according to the photos.

Fit the ejector seat in the vaccum part

Pilot : cut the pilot legs
Fit it in the cockpit



Air intake Fairings :

Cut the vaccum part according to the photo

Glue them on the air intake with CA



Gear locking mechanism fairings :

Cut the vacuum part according to the photo

Glue them on the air intake with CA



Front gear fairing :

Cut the 3 vacuum part according to the photo

Glue the big rear part under the fuselage with CA

Glue the small front part on the front gear door

Install a hinges on the rear part and meium part.

Screw the 5 mm aluminium tube on the oleo leg.

Glue the 6 mm tube on the hinges

Drill a hole in the fuselage so that the aluminium tube can go in the fuselage when the nose gear goes up

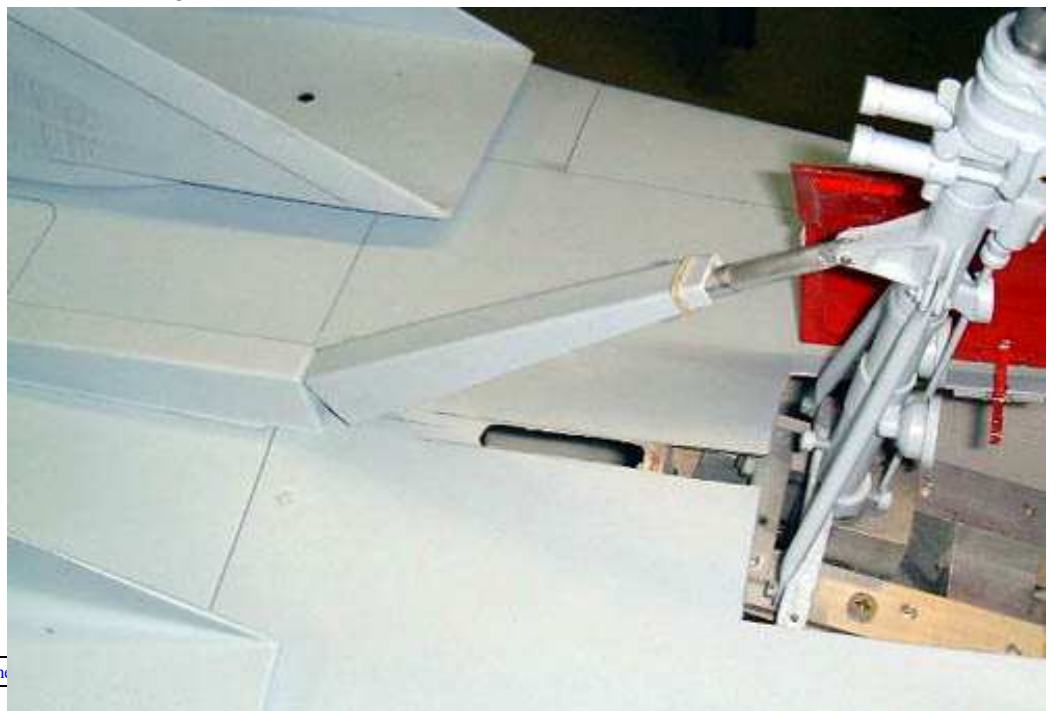

Stab servo fairings :

Cut the vacuum part according to the photo

Glue them on the stabs with CA

Check that the stabs can move without problem



Pitot :

Drill a 2 mm hole in the fuselage.

Glue the 2 pitot with CA.

Secure it inside with epoxy.



Ventral fins:

Fit the ventral fins under the fuselage.

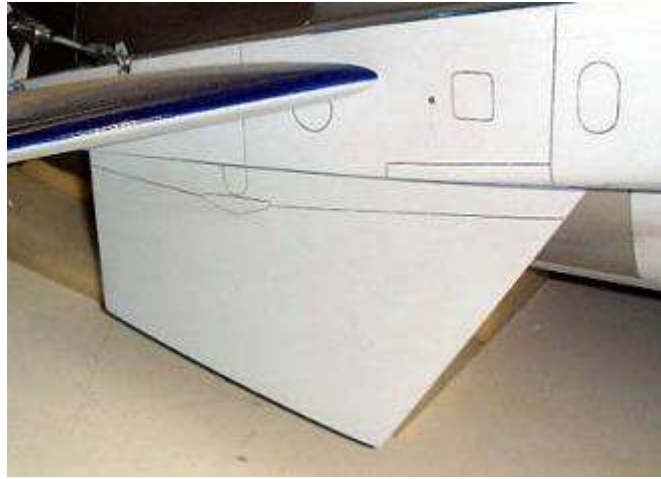

Engine installation.

For less CG problem, you will have to fit the engine as forward as possible on their mounting.

Fit the engine on their mounting

Drill 4 x 2 mm hole and insert the parker screw in the wood.

Drill a hole for all the tubing and engine connector.

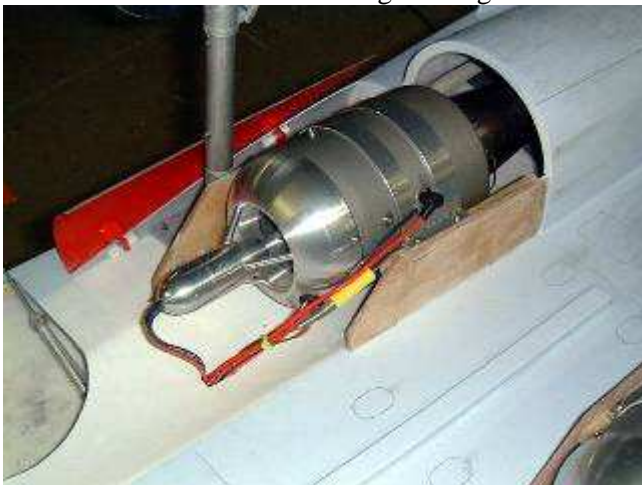

Exhaust tube

Fit the aluminium ring on the exhaust tube.
Rivet the 2 part together.
Insert 3 x M3 screw in the aluminium ring to adjust the clearance between the engine and the exhaust tube.
The exhaust tube must just overlap the engine exhaust cone.

Fit the exhaust in the fuselage

Screw an aluminium pad on the exhaust to fit it on the main rear frame

Important : Protect all electric wire with ceramic fiber.

The rear exhaust cone can be fitted with 3 parker screw or with silicon glue.



FINISHING TIPS

Now you have to remove the wax from all the parts to paint.
The best way to do this is to sand all the surfaces with a "scotch brit" scouring pad used to wash up the crockery
All the parts can also be sanded with #400 grit paper to remove wax.

Do not apply primer on the fuselage, wings, stabs and fins.

They must be directly painted.

Think light : excessive paint build-up will add unnecessary weight to the model. Apply light, thin coats of paint and sand between coats to avoid excess weight.

Radio, ECU, batterie, tubing... installation :

Connect all the engine tubing to the fuel pump.
Connect the fuel pump to the fuel tank.
Connect all the engine connector the the ECU.

Connect all the retract tubing according the manual to the air valve.

Connect all radio wire



Fit the radio and ECU close to the cockpit

Fit the ECU batterie and radio batteries in the nose (on the C33 frame)

Secure all the screw with threaded lock.



RADIO

The Sukhoi 27 needs very good servos :

For the 2 tailerons, we recommend to use 4 very good servos with metallic gears : 9 kg torque

NG steering : 1 servo 4 kg torque

Retract + gear doors + locking : 3 micro servos 1 kg torque



You normally need 2 x 1700 Mah batteries power to have a correct Center of Gravity. The correct CG is drawn on the plan in attach.

Note : balance the model with the gear down and **the fuel tanks empty.**

You also need 1 electronic mixers on your radio.

You must mix the 2 tailerons like a delta.

Taileron : in roll : 30 mm up and 30 mm down at the leading edge
 in pitch : 40 mm up and 40 mm down at the leading edge

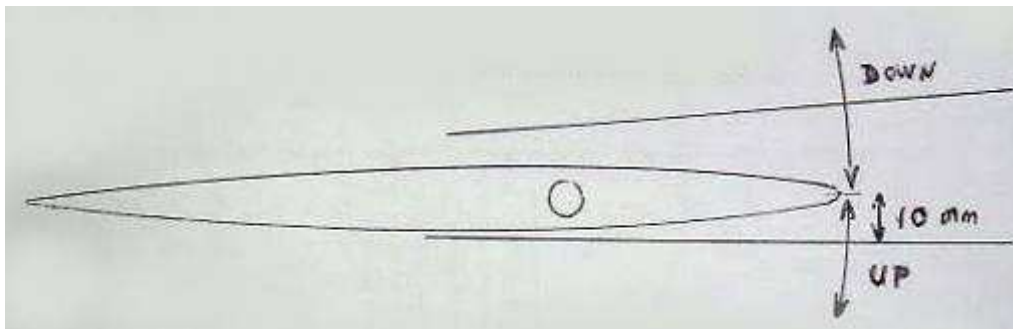

With a Mercury engine or a RAM engine, the total weight of the Su 27 is 19 kg tanks empty

Important note : Pay very careful attention to structural integrity. This jet can reach speeds of over 300 KPH. It is your responsibility to operate it safely.

Specifications may change without notice.

Sukhoi Su 27

CG Position

CG Position
Empty tanks

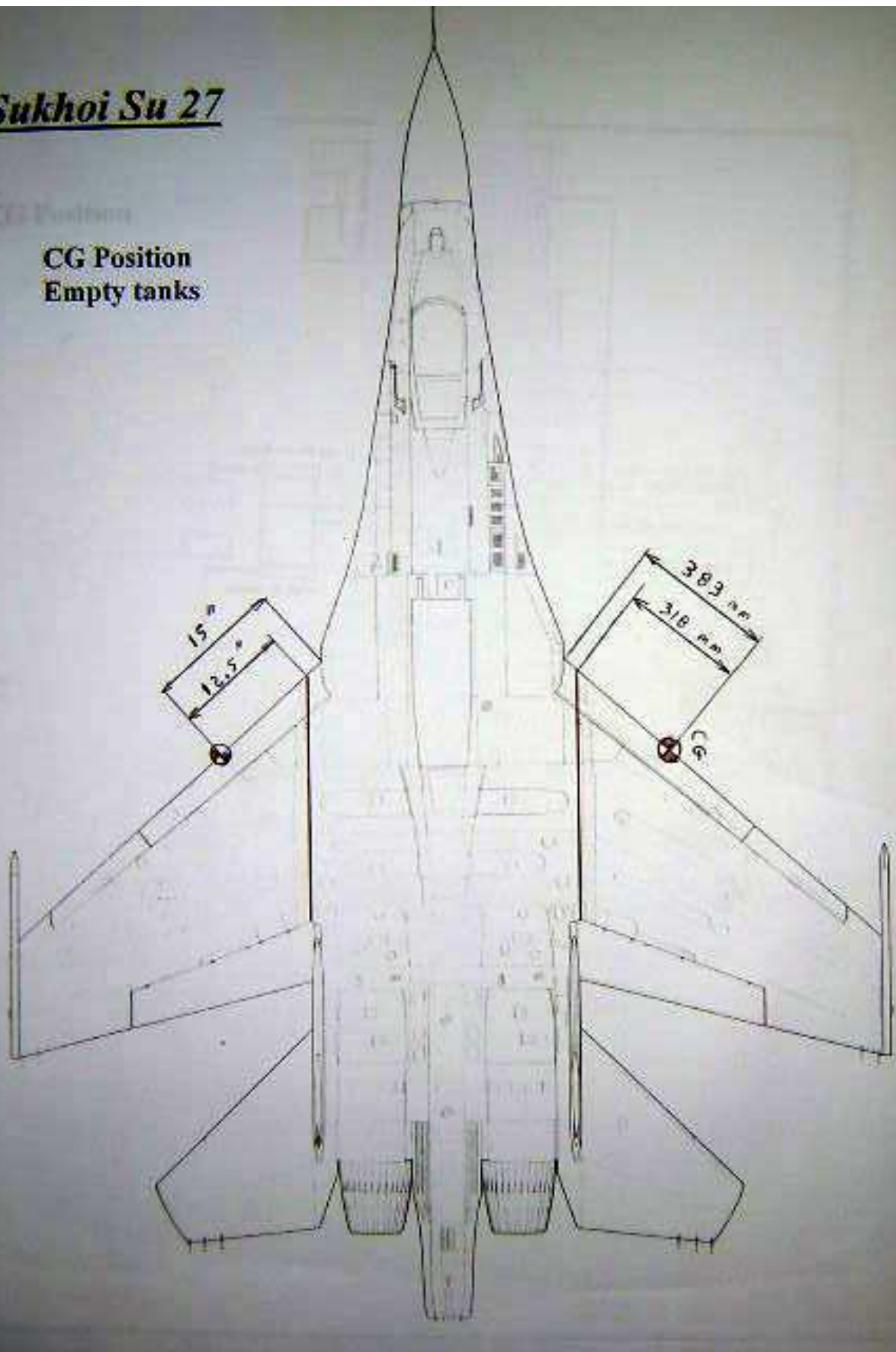

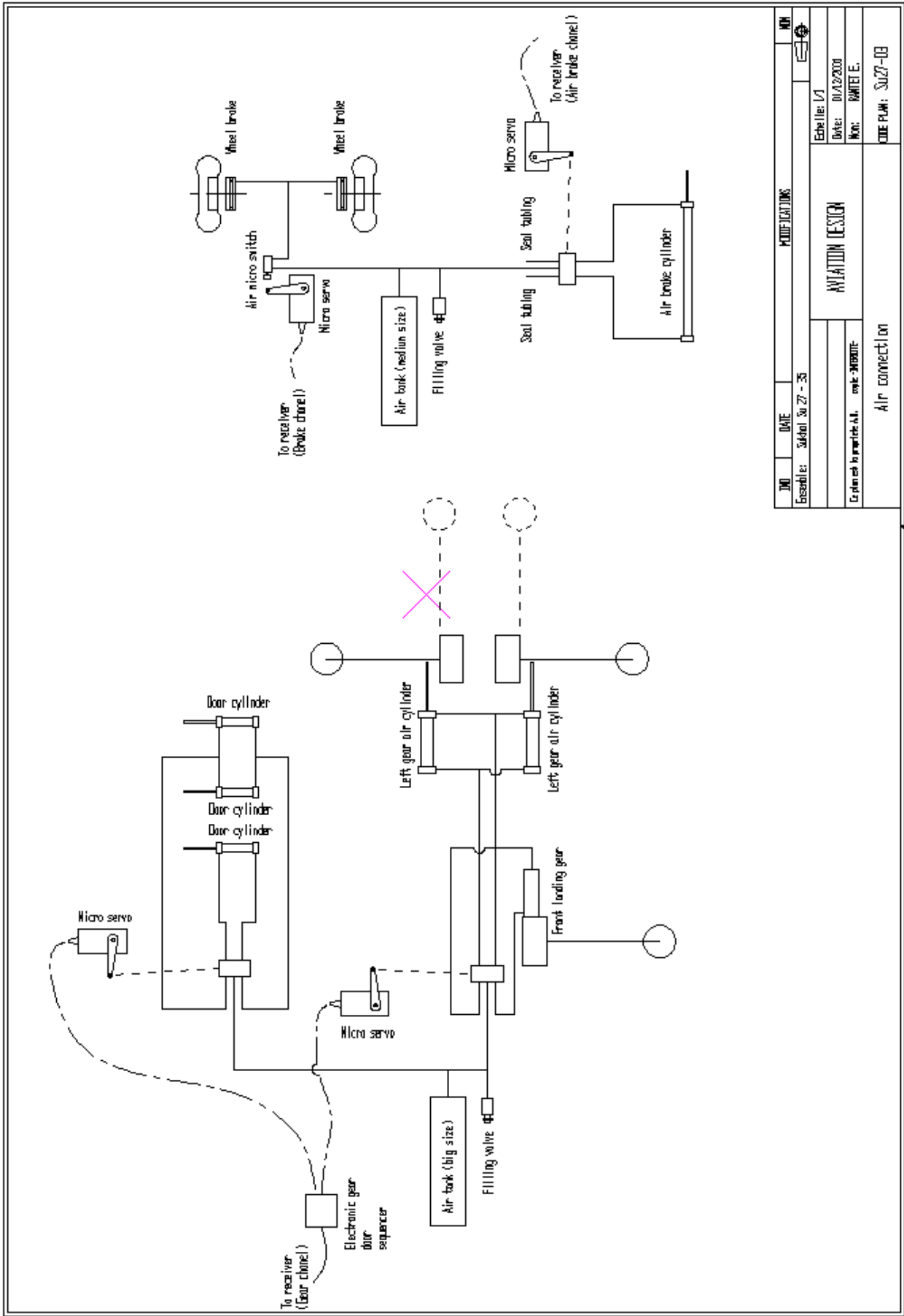

NO	DATE	MODIFICATIONS	REV
Essentiel: Suédois	30/27-35		1/1
AVIATION DESIGN			Échelle: 1/1
			Date: 01/12/2008
			Nom: RANJET E.
Ce plan est la propriété A.D. - avion - AVIATION			CODE PLAN: Su27-103
Air connection			

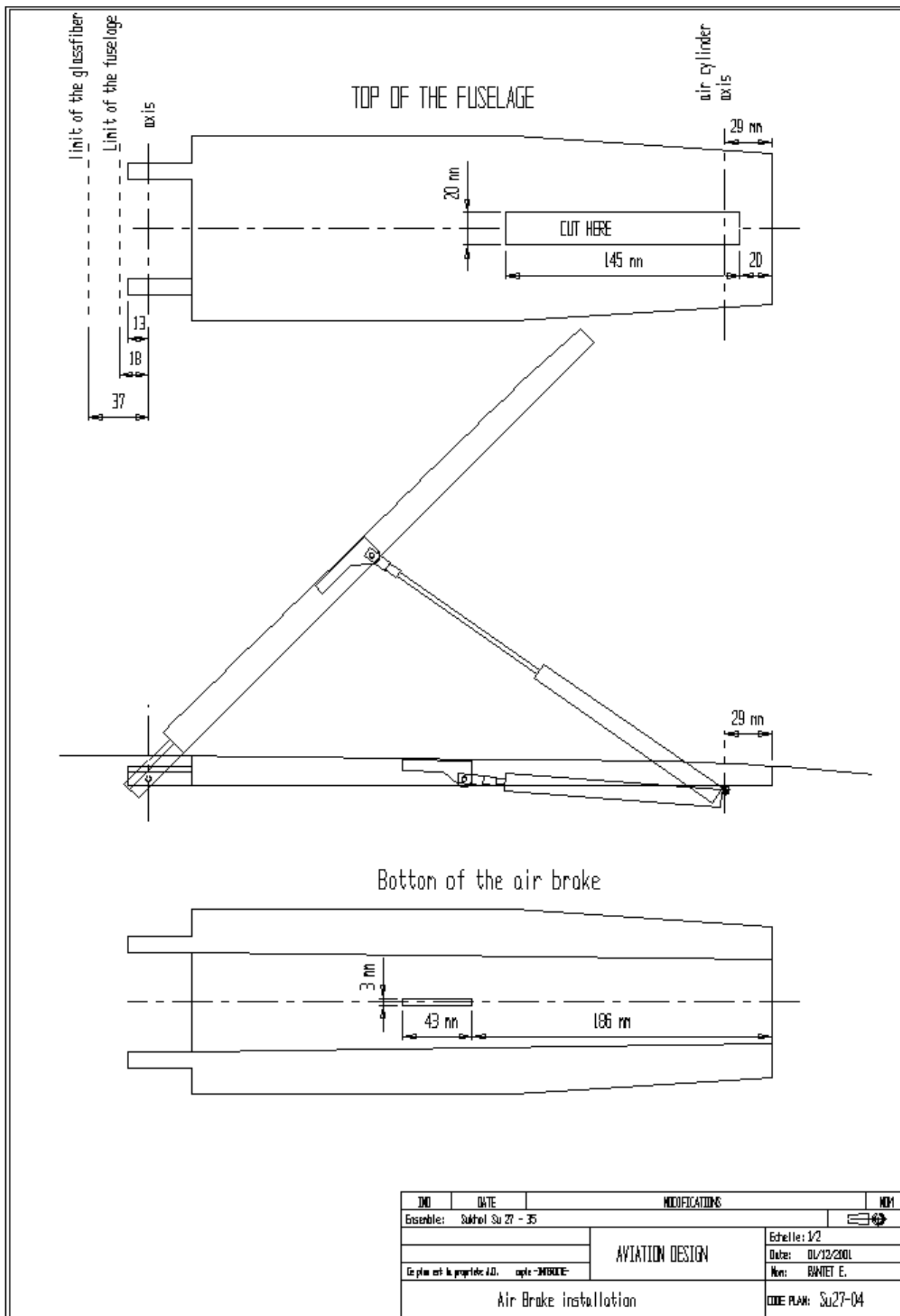

IND	DATE	MODIFICATIONS	NOM
Ensemble: Sukhoi Su 27 - 35			
		AVIATION DESIGN	Echelle: 1/2
			Date: 01/12/2001
Et plan est la propriété A.D. copie -IMBRODE-			Nom: BANTET E.
Air Brake installation			CODE PLAN: Su27-04

